



# MF RB SERIES

Variable Chamber Round Balers

MF RB 4160V & MF RB 4180V



FROM MASSEY FERGUSON



# Contents



**Page 06**  
High speed pick-up



**Page 08**  
Hydroflexcontrol - two stage protection system



**Page 09**  
Bale chamber



**Page 12**  
Monitoring and Control



**Page 13**  
Experience, innovation and durability

- 03 High quality fodder and straw
- 04 Variable Chamber range
- 05 A closer look at the MF RB Series variable chamber round balers
- 06 High speed pick-up
- 07 Xtracut for optimum cutting performance
- 08 Hydroflexcontrol - Two stage protection system
- 09 Bale chamber
- 11 Wrapping options
- 12 Monitoring and Control
- 13 Experience, innovation and durability
- 14 Customer support
- 15 Specifications & Options





# MF RB SERIES



Whether baling silage, hay or straw, farmers are always looking for high output, cost effective and flexible solutions to produce quality, dense bales which are easy to transport and require minimum storage space.

Consistent bale density is essential for all baled products, and the new range of MF variable chamber round balers offer farmers the best solution due to their class-leading compaction, cutter and pick-up capabilities. As a result, they are the ideal choice for those looking for high throughput and quality fodder or straw.

For silage requirements, these balers produce tight, well-shaped bales, which are a prerequisite for the fermentation process needed to retain the crop's essential nutrients for forage.

In hay, straw and biomass, the MF RB Series Balers form dense bales which are easy to handle and stack. They also retain their quality for a long period of time.

The MF variable chamber round balers are therefore suitable for a diverse range of farms and contracting businesses, including mixed, arable and livestock.





## MF RB Series Round Balers

### Variable Chamber range



Massey Ferguson RB 4160V and RB 4180V round balers share a common platform and produce bales from 0.9m up to 1.60m or 1.80m in diameter respectively.

2.00m, 2.25m or 2.40m pick-up options with a camless design offer a higher working speed, reduced maintenance and a much quieter operation in the field.

A range of models, with feeder rotor or cutters with 13, 17 or 25 knives is available.

Four seamless, double-ply belts provide smooth running and exceptional service life.

The Constant Pressure System (CPS) combines spring and hydraulic action and ensures constant pressure during the bale formation, depending on the selected bale diameter.

Varionet, the net wrapping system, can handle all net widths and provides excellent side-to-side bale coverage for improved stability in transit and storage.



## A closer look at the MF RB Series variable chamber round balers

Twine / Net wrapping options for flexibility

Powersplit gearbox ensures optimum power distribution

E-link or E-link Pro  
Key functions controlled from the tractor seat

Camless pick-up – high speed feeding with low maintenance

Patented bale development with sliding tail gate and constant pressure system for the best bale density

Mechanical tail gate lock maintains bale shape

Automatic chain lubrication reduces maintenance time

Xtracut cutter - flexible choice for cut length

Hydroflexcontrol - time saving two stage anti-blockage system

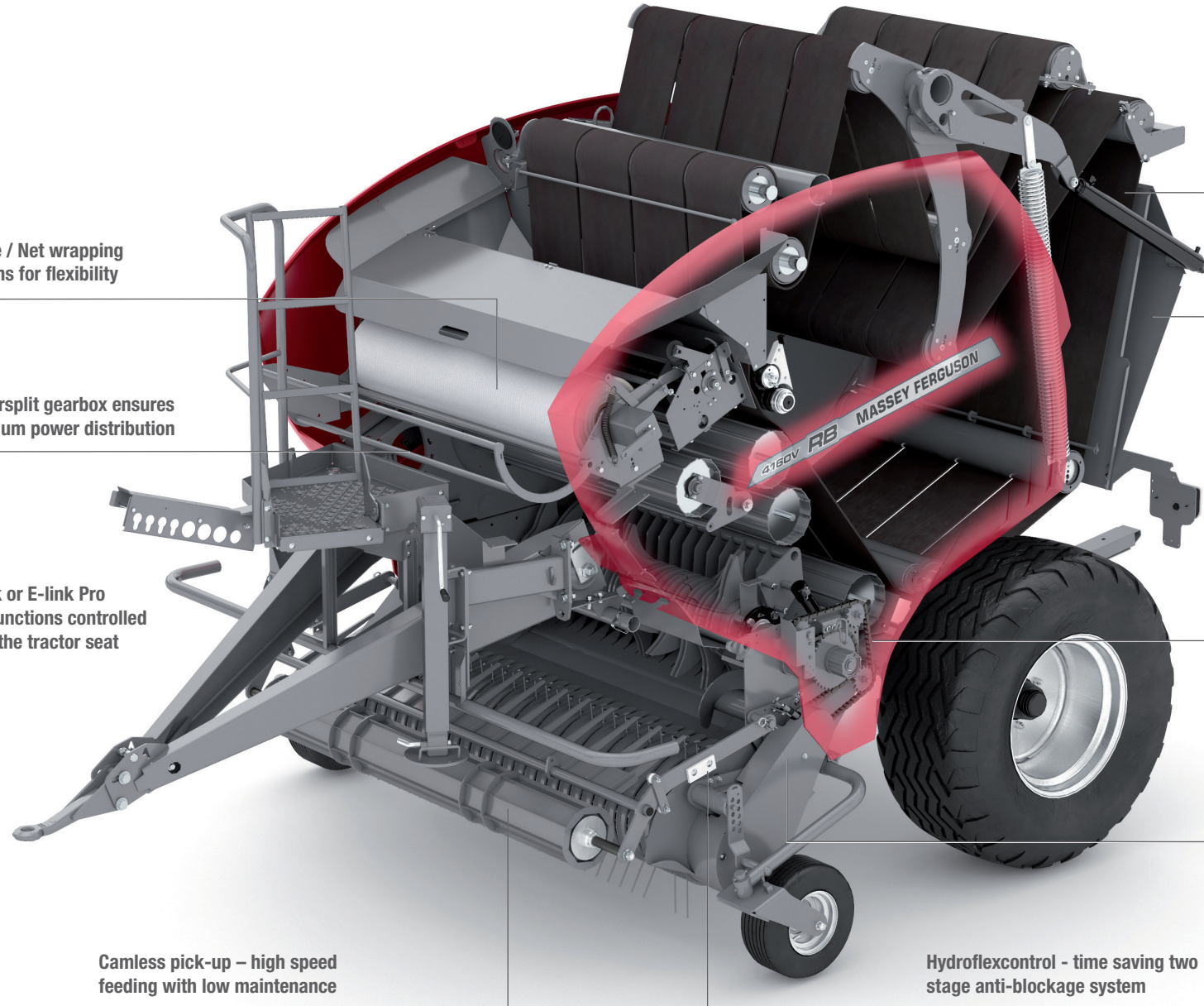



## High speed pick-up

Higher operating speeds are possible with the Massey Ferguson camless pick-up design.

With fewer moving parts, the camless pick-up is quieter, simpler and more reliable. Low maintenance and less adjustments save time and increase productivity.

The pick-up system has five tine bars with each one being spaced only 64mm apart, providing higher capacity and a smoother even feed at high speed.

On the Massey Ferguson round balers, the pick-up is positioned very closely to the rotor, therefore improving crop flow and reducing the risk of blockage.



### Crop press roller option

A reinforced crop press roller equipped with rake is fitted as standard to enhance crop flow into the chamber



### Heavy duty tines

5 rows of heavy duty tines with large coil diameter for enhanced durability in silage and stony conditions.



## Xtracut for optimum cutting performance

Chopping silage whilst baling offers several benefits:

- **Improves** forage quality resulting in better fermentation and palatability
- **Saves time** allowing a faster distribution of silage
- **Reduces waste** during feeding
- **Helps to achieve greater density** thus reducing haulage & wrapping costs

Designed for optimum performance, Massey Ferguson round balers can be equipped with 13, 17 or 25 knives. Cutter units are fitted with the longest knives on the market, making sure that no material will pass through uncut.

**Xtracut 17** and **25** feature two sets of hydraulically operated knife banks with separate control from the cab depending on customer requirements.

**The operator can select:**

- A single knife bank
- Both knife banks
- Disengagement of all knives



**Xtracut 13** rotor features 90mm crop cutting length

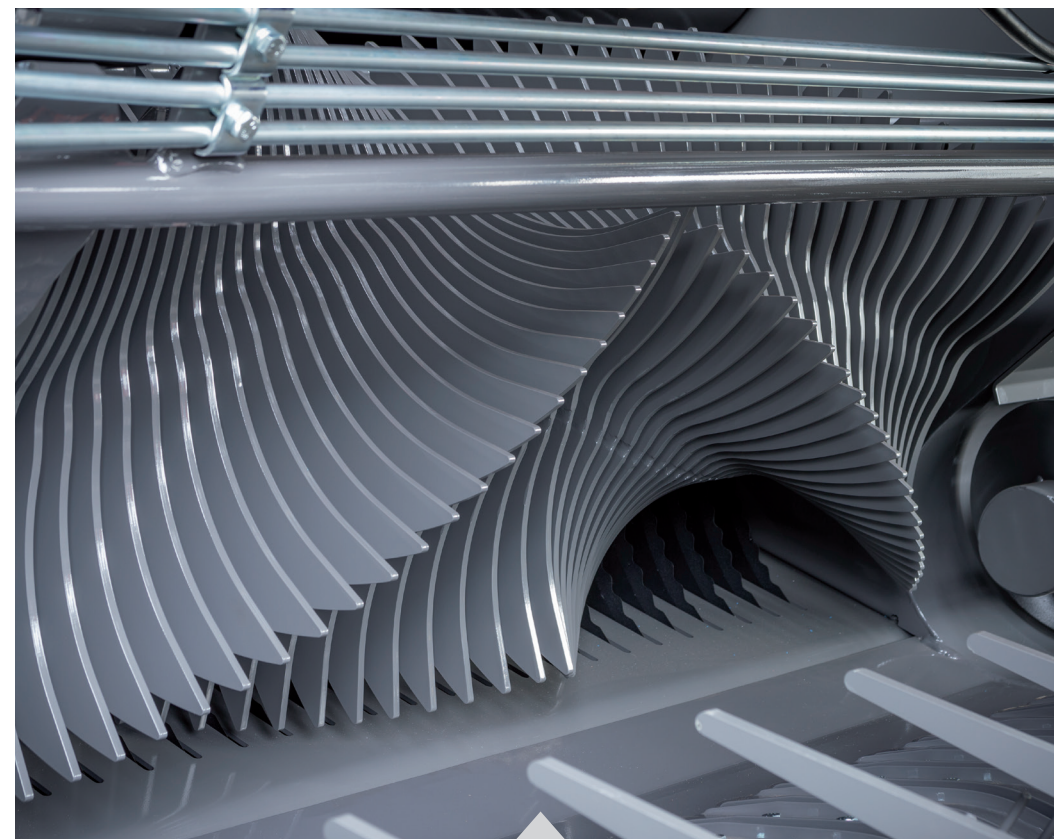

**Xtracut 25** rotor has 4-tines design increasing chopping capacity



## Hydroflexcontrol - Two stage protection system

Racing against weather and time to gather the best quality crop is always a challenge for man and machine.

To maximise efficiency in the field and minimise downtime from crop blockages, the MF Round balers are fitted with the unique Hydroflexcontrol protection system which works in two stages:

**Stage 1.** Automatic mechanical floor cushioning to clear minor blockages

**Stage 2.** Hydraulically controlled floor lowering to clear major blockages



The first stage of Hydroflexcontrol allows movement of the front part of the feed chamber floor and will automatically prevent up to 80% of potential blockages and will keep you going without unnecessary downtime.

Should a major blockage occur, stage two of hydroflexcontrol is activated by the operator, and is cleared by lowering the rear of the feed table floor hydraulically from the cab, allowing for material to easily pass through into the bale chamber, therefore minimizing downtime.

### Stage 1

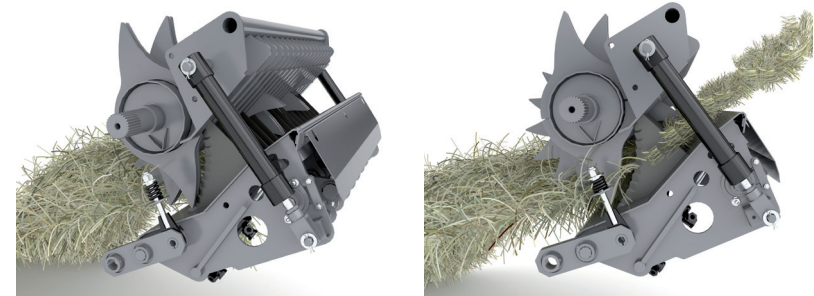

The patented protection system prevents peak loads from turning into blockages by gentle lowering of the floor which is suspended on rubber blocks or steel springs, depending on the model.

### Stage 2



In the event of a blockage the operator can easily open the feed table floor and lower the knives at the same time to provide enough space for material to pass through.



## Bale chamber

The bale chamber side panels are securely aligned during the production process with two large diameter tubes welded to the frame, providing a hard-wearing and rigid connection for extended durability and better bale density control.

Four durable, double-ply, seamless belts have excellent grip on the bale. With two stretch-resistant core layers made of a special synthetic material, the belts can withstand high loads when forming heavy silage bales.

A patented bale formation system features a sliding tailgate that moves downwards as the bale forms allowing the growing bale to move backwards. The bale chamber has a small bale start-off section with two additional rollers for better bale core formation.

The benefits are as follows:

- **Reduced pressure on the intake area**
- **Even pressure distribution along all components involved in bale shape and density**
- **Reduced power requirements**

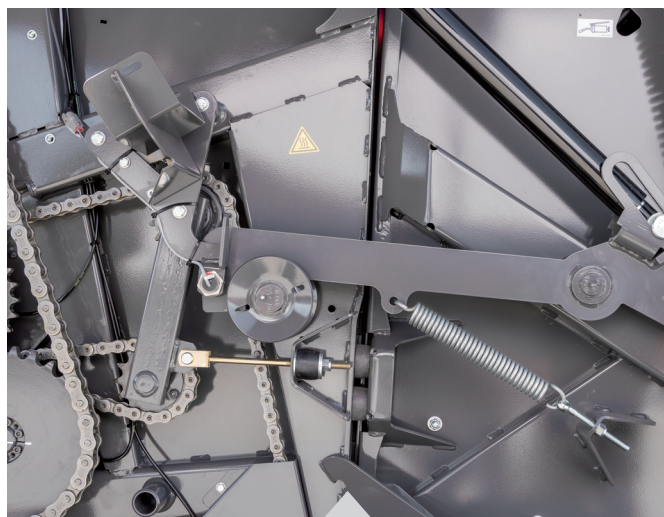

Mechanical tail-gate locking device; simple, fast and efficient, resulting in uniform bale diameter, high density bales and lower power consumption.





## Bale chamber



Bale volume increases exponentially in relation to its diameter, together with a corresponding belt pressure, to keep the bale density constant.

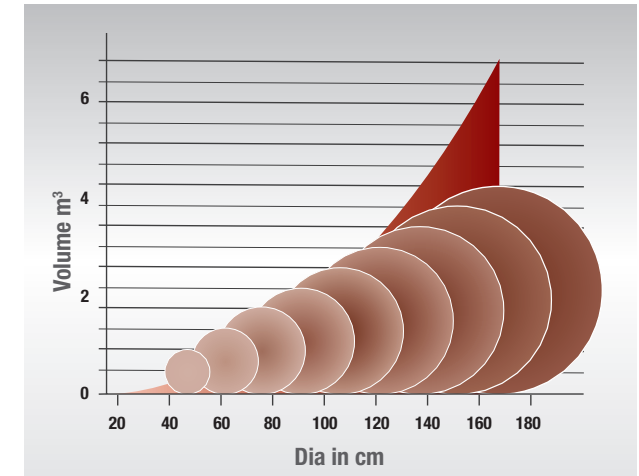

The Massey Ferguson **Constant Pressure System (CPS)** retains pressure using two large springs during bale formation, thus maintaining the correct pressure from the core outwards. Once the core is formed, the hydraulic system takes over, which increases the pressure until the complete bale is formed. This keeps the bale surface pressure constant throughout the complete cycle.

The end-result is uniform round bales with a firm and consistent shape, making them easy to handle and store with excellent crop conservation.

Depending on the baler specification, the maximum hydraulic system pressure in the bale tensioning arms can reach 140 or 180Bar.



## Wrapping options

The tried and tested Varionet net wrapping system features a special net tensioning and spreading device that is capable of dealing with various widths and types of net allowing for fast wrapping of bales from edge to edge or over the edge.

Perfect wrapping of perfectly formed bales is provided by the Varionet or Variotwin systems, saving cycle time, tying materials and preserving bales for safe handling and storage afterwards.

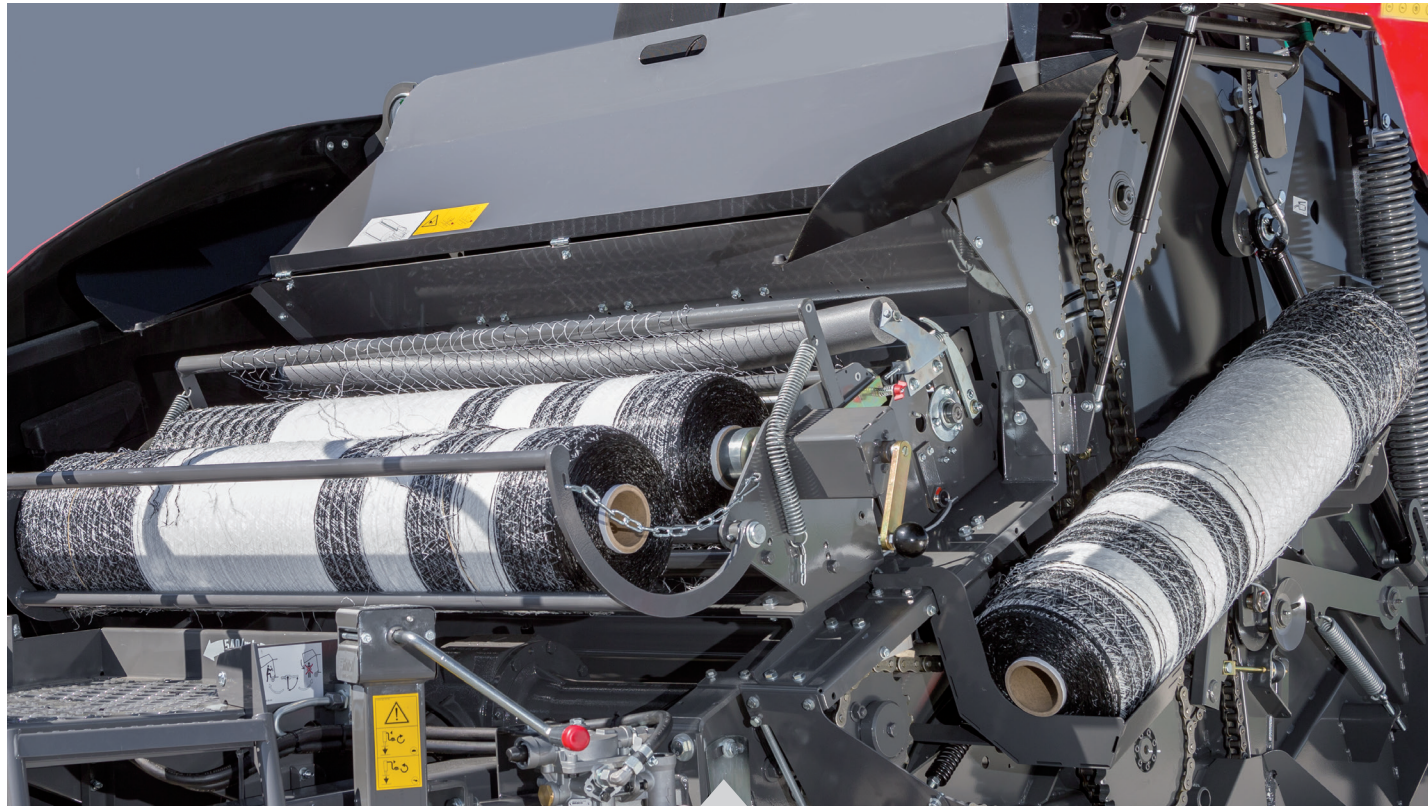

The **Easy Loading System (ELS)** allows one spare roll to be carried on the baler, allowing for roll replacement to be made in a matter of minutes. In addition to ELS most specifications feature storage for an additional, third net roll on the left hand side of the baler, increasing effective time in the field even further.



The optional Variotwin twine system offers simple and economical bale tying. The unique Variable Speed Control allows for additional twine revolutions on the bale edges, securing bale ends and increasing overall tying speed, which is particularly beneficial when baling light crops.



## Monitoring and controls

The **E-Link Control** unit offered on Massey Ferguson round balers allows the operator a great overview of the key baler processes with all adjustments made through the monitor. Its High Definition screen provides clear working images.

The following functions can be controlled with the E-Link Control terminal:

- Knife selection
- Bale pressure adjustment
- Bale size adjustment
- Net layer adjustment
- Net start/stop/pause
- Visual bale chamber filling
- Softcore bale on/off
- Bale counter
- Total bale counter
- Customer settings
- Sensor and actuator settings



The **E-Link Pro** monitor with integrated ISOBUS technology features a large bright screen which offers great visibility of multiple parameters, giving the operator more information and control of the baler. If a tractor is fitted with ISOBUS control it is also possible to use the tractor's monitor to view all the key information about the tractor and the baler in one place.

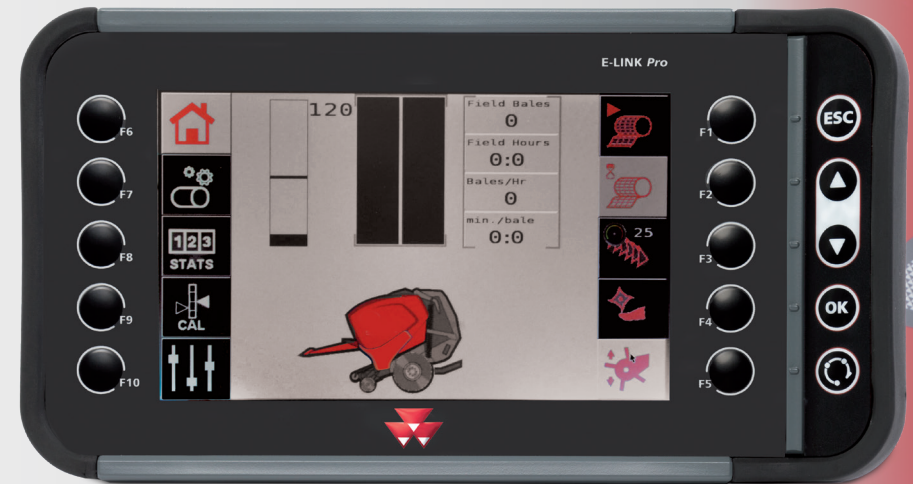

Specific field or customer information, such as the number of bales or hours worked, can easily be set and collected with the Wizard menu and later exported via USB connection for easy management of records and further performance analysis.



## Experience, innovation and durability

Massey Ferguson is a world leading brand with extensive experience in hay and forage production on all continents.

The Massey Ferguson round baler range is built to last and designed to exceed your expectations...

The number of unique and patented features make our balers stand out from the crowd.

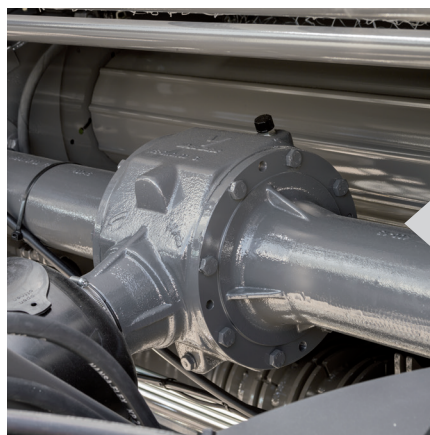

The Powersplit gearbox equally divides and transfers power to drive the rotor unit on one side and the roller drives on the other, reducing the overall power requirements by simplifying the drivelines. This results in a more efficient baler which uses less fuel.



Automatic chain lubrication with individual adjustment for each chain guarantees sufficient oil supply, reduces maintenance time and extends chain service life. For added durability the highest quality chains are used throughout the baler.



Full width side doors provide easy access for maintenance. The smooth surface design prevents dust accumulation beneath the panels while secure locking prevents unintended opening and potential damage.

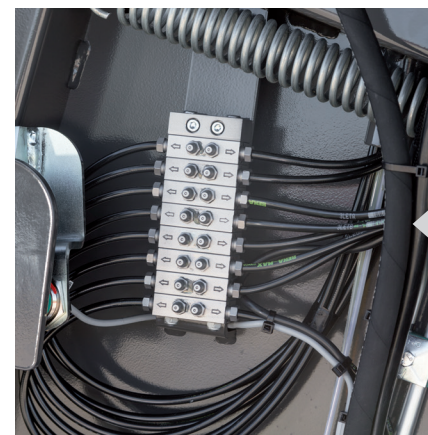

Regular and sufficient lubrication of roller bearings is extremely important, particularly in adverse conditions, for example when baling silage. Centralized grease banks for roller bearing lubrication are located in convenient positions for easier access and reduced service time.



# Customer support

Dedicated service and dynamic support



Massey Ferguson is a true global brand with machines operating all over the world, and behind every Massey Ferguson machine is the powerful after sales support of AGCO's Customer Support organisation.

Industry benchmarking shows that AGCO offers customers world-class parts and service support, and this is never truer than in support of our harvest machinery both in and out of season.

Agriculture can be a tough business, that's why we make sure that you can get support whenever you need it and at crucial times of the year. Our dealers are committed to finding the right product for you and then supporting you with the best service, parts provision and back up. You'll be part of a dedicated family of highly skilled specialists who make it their business to give you genuine, top quality service support.



# Specifications as standard

Model	MF RB 4160V Classic	MF RB 4160V Xtracut	MF RB 4180V Classic	MF RB 4180V Xtracut
<b>Bale Chamber</b>				
Diameter, m	0.90 - 1.60	0.90 - 1.60	0.90 - 1.80	0.90 - 1.80
Width, m	1.23	1.23	1.23	1.23
Volume, m <sup>3</sup>	2.48	2.48	3.15	3.15
Maximum belt tension pressure, bar	140/180	140/180	140/180	140/180
Mechanical chamber locking	●	●	●	●
Varionet net wrapping	●	●	●	●
Net and Twine tying unit	○	○	○	○
Bale ramp	●	●	●	●
<b>Pick-up</b>				
Width, m	2.00 / 2.25	2.25 / 2.40	2.25	2.25 / 2.40
Rake to rake width, m	1.60 / 1.86	1.86 / 2.12	1.86 / 2.12	1.86 / 2.12
Pick-up tine spacing, mm	64	64	64	64
Press roller with rake	●	●	●	●
<b>Feeding</b>				
Feeder Rotor	●	-	●	-
Hydroflexcontrol	-	●	-	●
Xtracut, 13-knife cutter	-	○	-	○
Xtracut, 17-knife cutter	-	○	-	○
Xtracut, 25-knife cutter	-	○	-	○
<b>Monitoring</b>				
E-link Control monitor	●	●	●	●
E-link Pro monitor	○	○	○	○
<b>Tractor requirements</b>				
Recommended horsepower, kW/HP	60 / 80	>100	60 / 80	>100
PTO, rpm	540	540	540	540
Hydraulic spool valves	2	2	2	2
Tyre options	15.0/55-17 19.0/45-17	15.0/55-17 19.0/45-17 500/45-22.5 500/55-20	15.0/55-17 19.0/45-17	15.0/55-17 19.0/45-17 500/45-22.5 500/55-20
<b>Dimension and weights</b>				
Transport length, m	5.00	5.00	5.10	5.10
Transport height, m	3.05	3.05	3.15	3.15
Transport width, m	2.80	2.80	2.80	2.80
Approximate weight, kg	min. 3,690	min. 3,950	min 3,870	min 4,070
<b>Options</b>				
Hydraulic brakes	○	○	○	○
Air brakes	○	○	○	○
Variotwin - twine tying system	○	○	○	○

- Not available
- Standard specification
- Optional

Every effort has been made to ensure that the information contained in this publication is as accurate and current as possible. However, inaccuracies, errors or omissions may occur and details of the specifications may be changed at any time without notice. Therefore, all specifications should be confirmed with your Massey Ferguson Dealer or Distributor prior to any purchase.





# MASSEY FERGUSON

**A world of experience. Working with you.**



Web: [www.MasseyFerguson.com](http://www.MasseyFerguson.com)

Facebook: [www.Facebook.com/MasseyFergusonGlobal](http://www.Facebook.com/MasseyFergusonGlobal)

Twitter: [Twitter.com/MF\\_EAME](http://Twitter.com/MF_EAME)

Instagram: [Instagram.com/MasseyFergusonGlobal](http://Instagram.com/MasseyFergusonGlobal)

YouTube: [www.YouTube.com/MasseyFergusonGlobal](http://www.YouTube.com/MasseyFergusonGlobal)

Blog: [Blog.MasseyFerguson.com](http://Blog.MasseyFerguson.com)



MASSEY FERGUSON® is a worldwide brand of AGCO.  
© AGCO Limited. 2017 | A-A-16547/1117 | English/1117



Responsible forest management

